

# Cobra® 29 LX EU

## Operating Instructions for your Cobra 29 LX EU CB Radio



U.S. Patent Nos. D625279, D630202 & D630625

©2011 Cobra Electronics Corporation  
Printed in China  
Part No. 480-703-P Version D

Nothing Comes Close to a Cobra®

## Our Thanks to You and Customer Service

Thank you for purchasing the Cobra 29 LX EU CB Radio Transceiver. Properly used, this Cobra product will give you many years of reliable service.

### NOTICE!

Before using this transceiver, please check that the radio has been programmed on the frequency band specifications and operating modes allowed by the regulations valid in the country where the product is used. If not, please proceed to modify the frequency band programming, as described in this owner's manual page 17. This transceiver is programmed at the factory on the EU frequency band (40 CH AM 1W/40 CH FM 4W).

### Customer Assistance

Should you encounter any problems with this product, or not understand its many features, please refer to this owner's manual. If you require further assistance after reading this manual, please contact your local dealer.

### This equipment is intended for use in:

This equipment is intended for use in:											
AT	✓	DE	✓	GB	✓	IT	✓	NL	✓	RU	✓
BA	✓	DK	✓	GR	✓	LT	✓	NO	✓	SE	✓
BE	✓	EE	✓	HR	✓	LV	✓	PL	✓	SI	✓
BG	✓	ES	✓	HU	✓	LU	✓	PT	✓	SK	✓
CH	✓	FI	✓	IE	✓	MK	✓	RO	✓	TR	✓
CY	✓	FR	✓	IS	✓	MT	✓	RS	✓	UA	✓
CZ	✓										

✓Countries of use

### For Warranty, Product Service and Accessory Information

Please contact your local dealer or distributor. See the enclosed leaflet, which provides contact information for the Cobra international distributors.

The Cobra line of quality products includes:  
**Downloaded from [www.cbradio.nl](http://www.cbradio.nl)**

- CB Radios
- microTALK® Radios
- Radar/Laser Detectors
- Safety Alert® Traffic Warning Systems
- Truck-Specific Navigation Systems
- HighGear® Accessories
- CobraMarine VHF Radios
- Power Inverters
- LED Lights
- Jumpstarters
- Accessories

For more information or to  
order any of our products,  
please visit our website:  
[www.cobra.com](http://www.cobra.com)

# Included in this Package

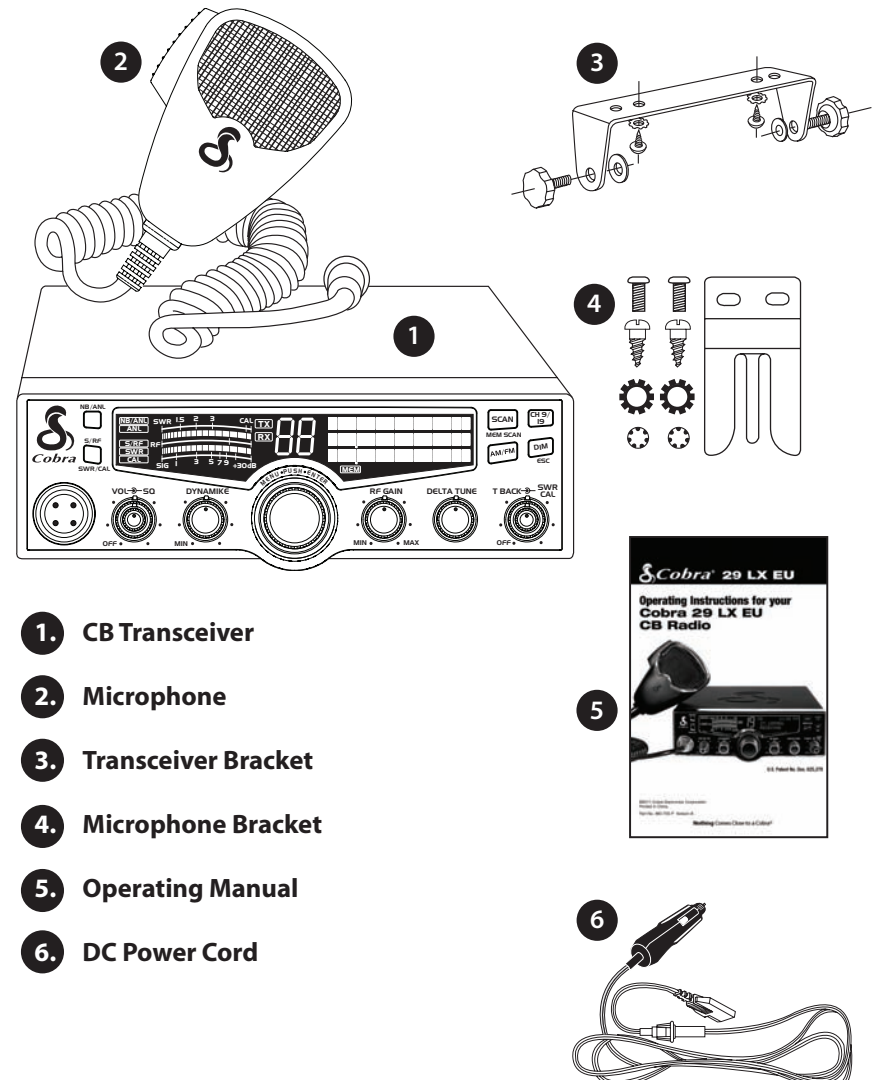

- 1. CB Transceiver
- 2. Microphone
- 3. Transceiver Bracket
- 4. Microphone Bracket
- 5. Operating Manual
- 6. DC Power Cord

# Controls and Indicators

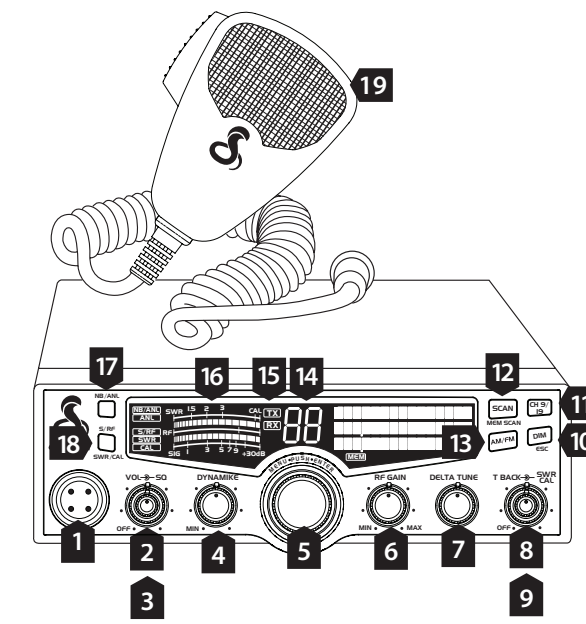

- Front Side**
- 1. 4-Pin Microphone Connector
  - 2. Power On/Off, Volume
  - 3. Squelch
  - 4. Dynamike
  - 5. Menu/Enter/Channel Selector
  - 6. RF Gain
  - 7. Delta Tune
  - 8. Talk Back Control
  - 9. SWR Calibration
  - 10. Dim/EscapE Button
  - 11. Channel 9/Channel 19 Button
  - 12. Scan/Memory Scan
  - 13. AM/FM Button
  - 14. LCD Display
  - 15. RX (Receive)/TX (Transmit), Indicators
  - 16. Signal Strength Meter
  - 17. NB/ANL Button
  - 18. S/Rf SWR CAL Button
  - 19. Microphone

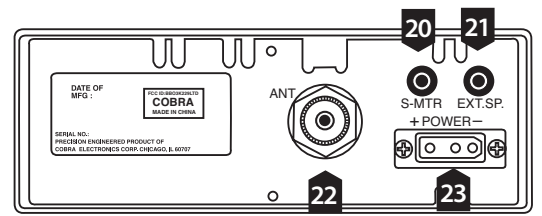

- Back Side**
- 20. S-Meter Jack
  - 21. External Speaker Jack
  - 22. Antenna Connector
  - 23. Power Jack

# 29 LX EU Fuses

## Replacing the In-Line Fuse

**Note**  
The radio is protected with a 2 fuse system in the event that the user decides not to use the cigarette lighter plug.

**Caution**  
For continued protection against fire hazard, replace with same type 2A, 250V fuses.

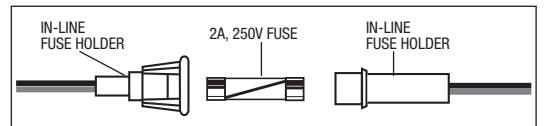

To replace the in-line fuse; push the ends of the holder together then turn counter-clockwise and pull the two sections apart.

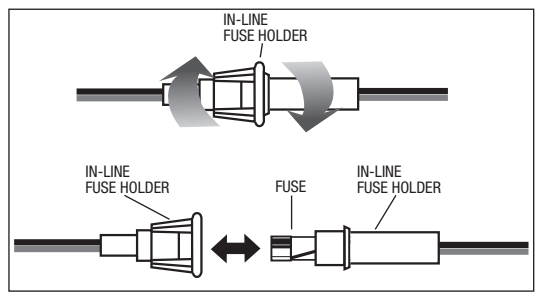

## Replacing the Fuse in the CLP

**Note**  
There is a retaining spring in the CLP used for tension connectivity.

To replace the fuse in the cigarette light plug (CLP), rotate the metal tip of the CLP to access the fuse.

Be sure not to lose the retaining spring within the holder.

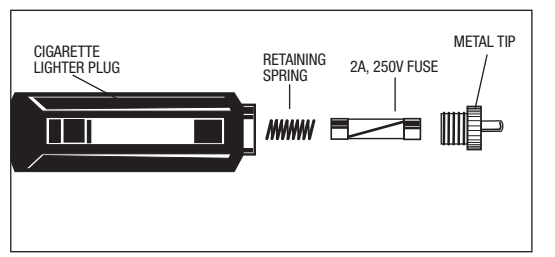

# How to Use Your Cobra 29 LX EU

## Contents

Our Thanks to You & Customer Service.....	A1
Included in this Package.....	A2
Controls & Indicators.....	A3
<b>Installation</b>	
Location & Mounting/Connection.....	2
<b>Antennas</b>	
CB Antenna & Marine Installation.....	6
<b>Ignition Noise Interference.....</b>	<b>7</b>
<b>Operating Your 29 LX EU</b>	
Turning On Your CB.....	8
Setting Channel Selector.....	9
Calibrate For SWR (Standing Wave Ratio).....	10
To Receive.....	12
Selecting a Channel.....	13
S/RF-Meter.....	13
To Transmit.....	14
Setting Dynamike®.....	15
Turn SoundTracker® On and Off.....	15
Menu Mode.....	16
Setting the Country of Use.....	17
Setting the Clock.....	17
Setting the Alarm.....	18
Setting the Count Down Timer.....	19
Key Tones Mode.....	19
Radio Check Mode.....	20
Setting Display Colour Mode.....	22
Setting Brightness Mode.....	23
Setting Contrast Mode.....	24
Software Version/Factory Settings.....	25
NB-ANL/Off (Noise Blanker/Automatic.....	26
Noise Limiter Switch)	
RF Gain Control.....	26
Program Memory Channels.....	27
Scan CB Channels.....	28
Scan Memory Channels.....	28
Dimmer Control.....	28
Setting Squelch.....	29
External Speaker.....	31
Home And Office Set-Up.....	32
Temporary Mobile Set-Up.....	33
<b>Frequency Ranges.....</b>	<b>34</b>
<b>29 LX EU Specifications.....</b>	<b>37</b>
<b>Optional Accessories.....</b>	<b>38</b>
<b>Declaration of Conformity.....</b>	<b>39</b>
<b>29 LX EU Fuses.....</b>	<b>40</b>

## Features of This Product

- AM/FM 1W/4W Multi-Country Programmable Transceiver
- Selectable 4-Colour LCD Display
- Scan
- Memory Channels/Scan
- Channel Frequency Read-Out
- Radio Check Diagnostic
- Clock/Timer/Alarm
- Heavy-Duty Dynamic Microphone
- 1/4W AM/4W FM RF Power Output
- SoundTracker® Noise Reduction
- SWR Calibration Meter
- Instant Channel 19 and 9
- Front Panel 4-Pin Microphone Connector
- Switchable Automatic Noise Limiter & Noise Blanker
- Adjustable Dynamike Boost
- Tactile Controls
- Programmable Dimmer Control
- RF Gain
- S-Meter Jack

## Location

### Location

Plan location of transceiver and microphone bracket before starting the installation.

Select a location that is convenient for operation, yet does not interfere with the driver or passenger.

The transceiver is usually mounted to the underside of the dash with the microphone bracket beside it.

## Mounting and Connection

### Note

The transceiver is held in the universal mounting bracket by two thumbscrews which allow for adjustment at a convenient angle.

The bracket includes two self-tapping screws and star washers. The mounting must be mechanically strong, conveniently located.

### Mounting and Connection

- 1 Hold the radio with the mounting bracket in the exact desired location. If there is no interference, remove the bracket and use it as a template to mark the location for the mounting screws.

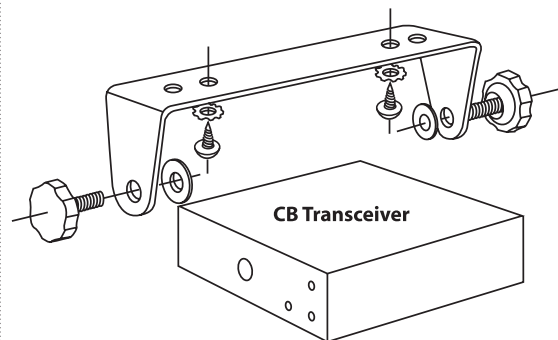

- 2 Drill the holes and secure the bracket.

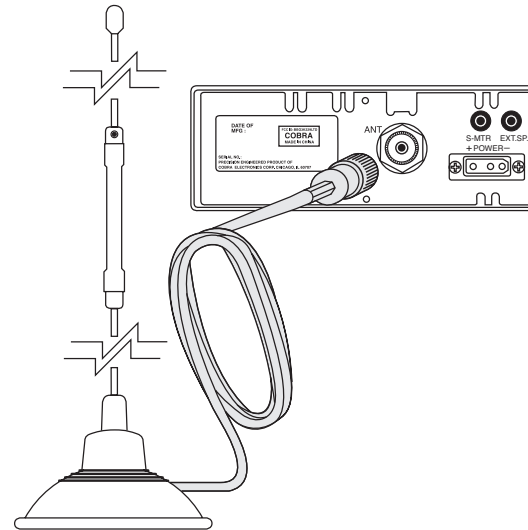

- 3 Connect the antenna cable plug to the receptacle marked "ANT" on the back of the unit.

continued

# Installation

## Note

Radio is 12V DC and can be connected via vehicle's cigarette lighter plug.

**Before installing the CB radio to the battery or fuse block, visually check the vehicle's battery connection to determine which terminal, positive or negative, is earthed (positive is the larger of the two) to the engine block (or chassis). A negatively earthed vehicle has its negative lead grounded to the chassis.**

## Note

Connecting to an accessory fuse prevents the unit from being left on accidentally, and also permits operating the unit without running the engine.

## Note

In positive earth vehicles the red wire goes to the chassis and the black wire is connected to the ignition switch.

12V Dashboard Connection

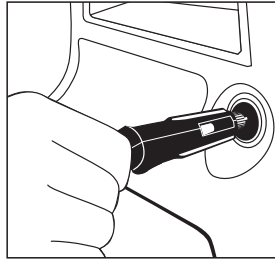

Direct Wiring

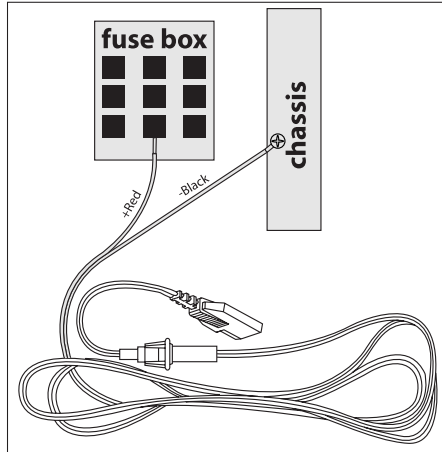

- 4 In a negative earthed vehicle, connect the red lead of the DC power cord to an accessory 12 volt fuse.
- 5 Connect the black lead to the negative side of the vehicle. This is usually the chassis. Any convenient location with a good electrical contact (remove paint) may be used.

# Installation

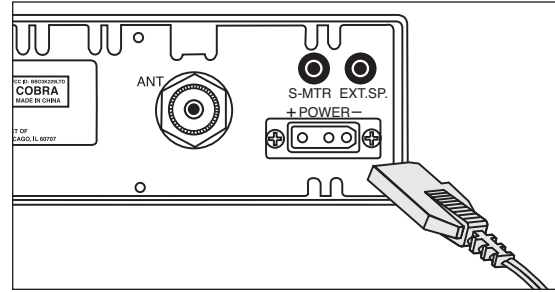

- 6 Plug power cable into back of unit marked "Power". Be sure to observe polarity markings.

- 7 Mount the microphone bracket on either side of the unit (driver's left) using two screws supplied. Bracket should be placed under the dash so microphone is readily accessible.

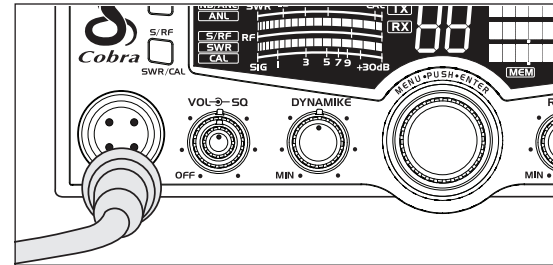
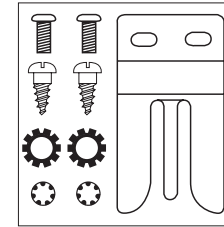

- 8 Attach the 4-pin microphone cable to receptacle on front of unit and install unit in bracket securely.

## Note

If microphone is not connected, audio will not be heard at speaker.

# Antennas

## CB Antenna

### Note

*For optimum performance in passenger cars the ideal antenna location is on the centre of the roof. Second choice is on the centre of the boot.*

### Note

*Because many newer trucks feature fibre glass door skins, the outside mirror must be earthed to the chassis via a earth strap, if the antenna is mounted on the mirror bracket.*

### Note

*3-way Combination Antennas are also available, which allow operation of all three bands (AM-FM & CB), using a single antenna. However, this type of antenna usually results in less than normal transmit and receive range when compared to a standard-type "Single Band" CB antenna.*

## CB Antenna

Since the maximum allowable power output of the transmitter is limited, the antenna is critical in affecting transmission distance. Only a properly matched antenna system will allow maximum power output. Cobra loaded type antenna models are highly recommended for most installations.

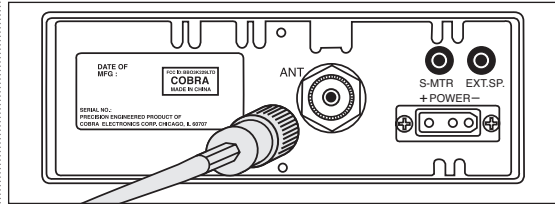

- 1 A standard antenna connector is provided on the transceiver for easy connection.

## Marine Installation

The transceiver will not operate at maximum efficiency in a boat without a ground plate, (unless it has a steel hull). Before attempting installation, consult your dealer for information regarding an adequate earthing system and prevention of electrolysis between fittings in the hull and water.

# Ignition Noise Interference

Use of a mobile receiver at low signal levels is normally limited by the presence of electrical noise. The primary source of noise in automobiles is from the alternator and ignition system. Typically, when signal level is adequate, the back-earth noise does not present a serious problem. Also, when extremely low level signals are being received, the transceiver may be operated with the vehicle's engine turned off. The unit requires very little current and therefore will not significantly discharge the vehicle's battery.

Even though the Cobra 29 LX EU has an automatic noise limiter, in some installations ignition interference may be high enough to make good communications impossible. Many possibilities exist and variations between vehicles require different solutions. Consult your Cobra dealer or a 2-way radio technician for help in locating the source of a severe noise.

## Turning On

### Note

Before using this transceiver, please check that the radio has been programmed on the frequency band specifications and operating modes allowed by the regulations valid in the country where the product is used. If not, please proceed to modify the frequency band programming, as described on page 17. This transceiver is programmed at the factory on the EU frequency band (40 CH AM 1W/40 CH FM 4W).

## Turning On

Make sure the power cord, antenna and microphone are connected to their proper connectors before starting.

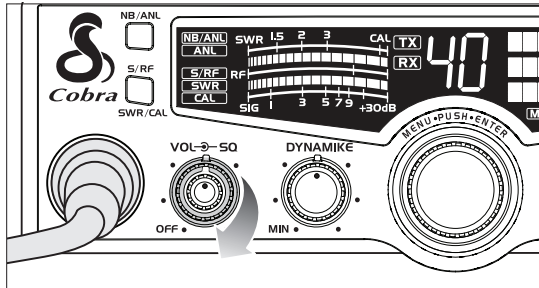

- 1 Rotate the **On/Off Volume** knob *clockwise* to turn unit on and adjust to a normal listening level.

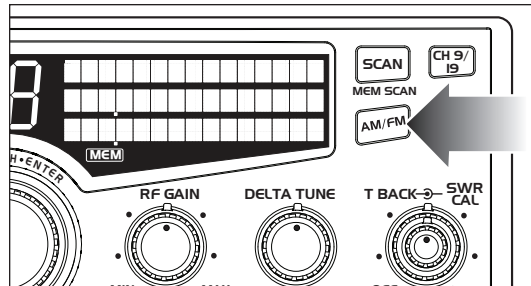

- 2 Press the **AM/FM** button to change bands.

## Setting Channel Selector

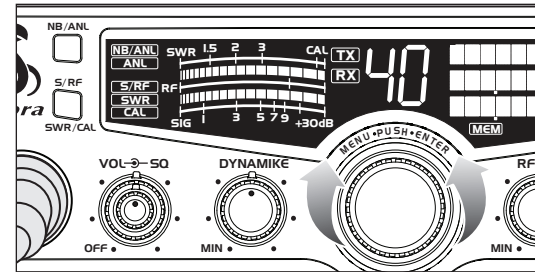

- 3 Select one of the channels and adjust volume. The selected channel will be indicated by the readout directly above the channel selector knob

## Setting Channel Selector

## Calibrate For SWR (Standing Wave Ratio)

### Calibrate for SWR (Standing Wave Ratio)

SWR calibration is done to properly adjust the length of the antenna and to monitor the quality of the coaxial cable and all RF connections. This calibration is critical in order to achieve optimum performance.

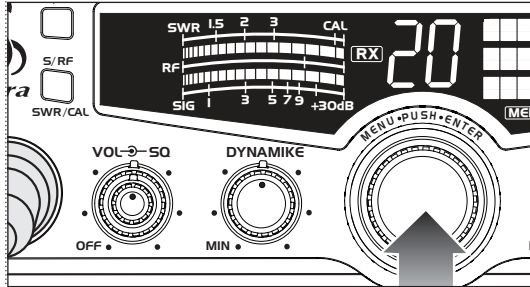

1 Select channel 20.

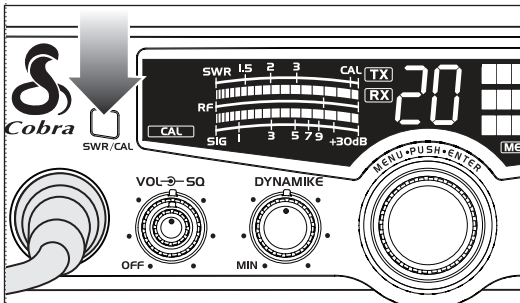

2 Press **SWR/CAL** button to select CAL.

**PUSH & HOLD**

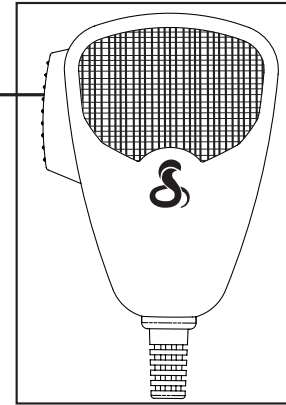

3 Push and hold mic button.

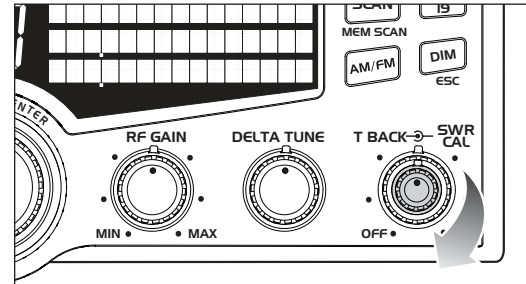

4 While holding mic button *adjust* the **SWR CAL** knob so the meter swings to the CAL mark on the meter (located on the right).

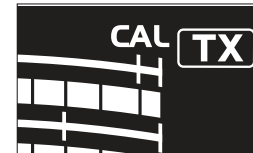

### Note

Calibration must be made in an open area (never indoors). Vehicle doors must be closed. No one should be standing near the antenna. (See your antenna directions for more complete information).

### Note

The reading will be slightly higher on Channels 1 and 40 compared to Channel 20.

continued

## Calibrate for SWR *continued*

### Note

When switched to SWR mode the meter reading should ideally be as far to the left as possible. Anything over 3 is not acceptable. A slight antenna height adjustment (higher or lower) may be required. Repeat recalibration steps.

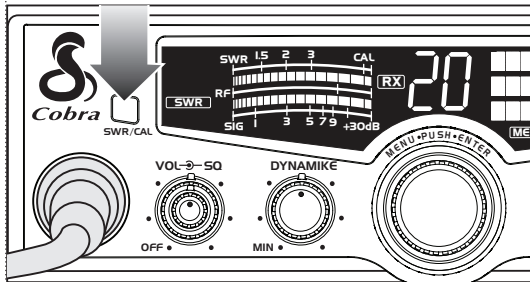

- 5 Release the PTT button, press and release the **S/RF-SWR CAL** button to the SWR position. Then press the PTT button to read the SWR reading.
- 6 Repeat the same steps two to five on Channels 1 to 40. This will check SWR for all channels.

## To Receive

### To Receive

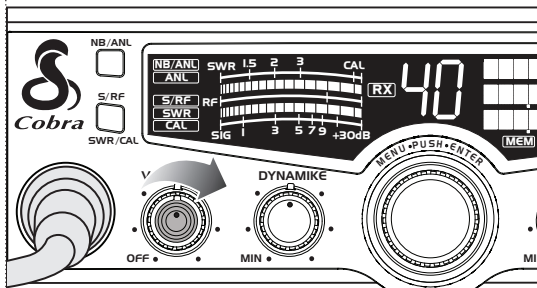

- 1 Rotate the **On/Off Volume** knob *clockwise*. The RX icon will be displayed.

## Selecting A Channel

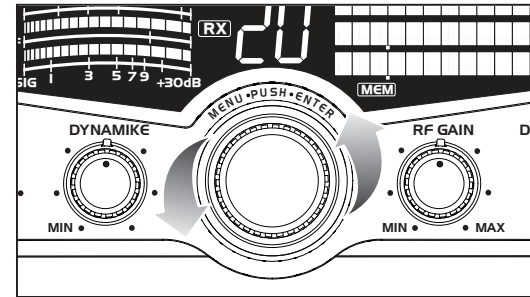

- 1 Rotate **channel selector** *clockwise* or *anticlockwise* to select desired channel.

## S/RF-Meter

Swings proportionately to strength of incoming signal when receiving.

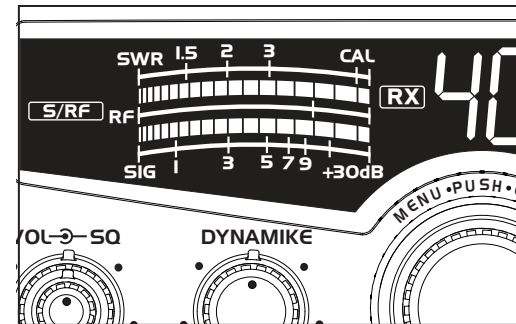

- 1 The **S/RF-SWR-CAL** switch must be in the S/RF setting to read the meter.

## Selecting A Channel

## S/RF-Meter

## To Transmit



### Caution!

Be sure the antenna is properly connected to the radio before transmitting. Prolonged transmitting without an antenna, or a poorly matched antenna, could cause damage to the transmitter.

### Note

Be sure the radio is programmed to the band that is allowed in the country of use.

## To Transmit

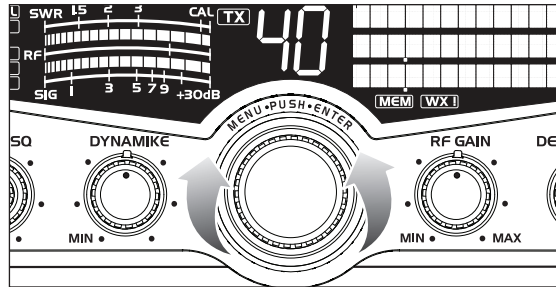

- 1 Select desired channel.

## Transmit

**PUSH & HOLD**

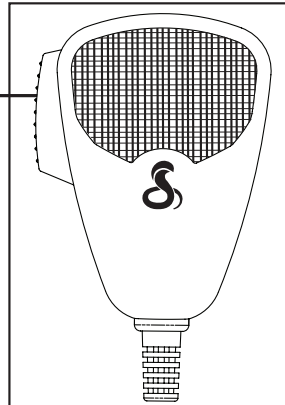

- 2 Push and hold mic button to transmit. Transmitter is now activated. When transmitting, hold the microphone two inches from your mouth and speak in a clear, normal voice. Release to receive.

## Setting Dynamike®

This controls the microphone sensitivity (outgoing audio level).

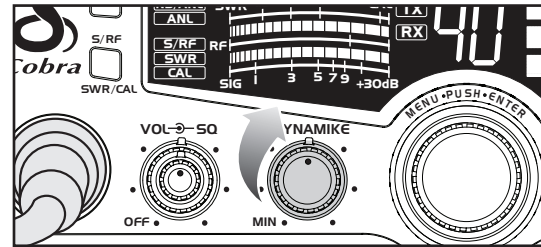

- 3 Initially, set fully clockwise so that maximum voice volume is available. Dynamike may have to be reduced in some conditions.

## Turn SoundTracker® On and Off

To activate SoundTracker® press **Menu/Enter** knob and select **ST ON/OFF**.

**ST** icon will appear in display.

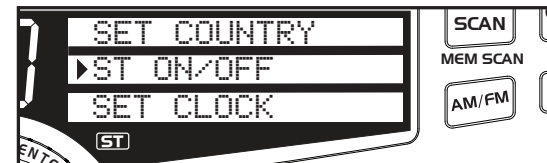

## Setting Dynamike®

### Note

Delta Tune is used to calibrate centre frequency.

## Turn SoundTracker® On and Off

### Note

SoundTracker® gives you clearer, cleaner reception to improve CB communications while on the air.

# Operation

## Menu Mode

### Note

Use Dim/Escape button to exit from any routine back to CB standby mode.

### Menu Mode

Used to program special features. **Menu/Enter** knob is used to move cursor to desired feature to program.

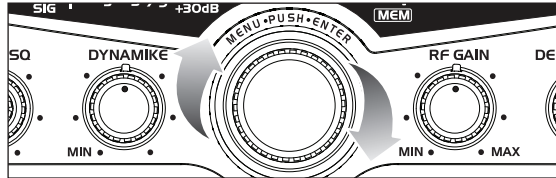

Rotate **Menu/Enter** knob *clockwise* to navigate menu levels.

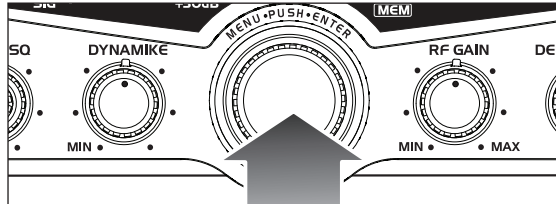

Press **Menu/Enter** knob to select feature to be programmed.

Level 1:

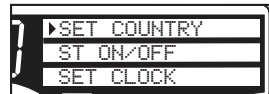

Level 2:

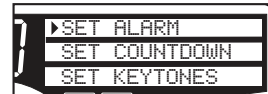

Level 3:



Level 4:

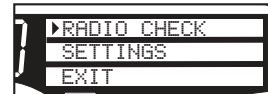

# Operation

## Setting the Country of Use

### Setting the Country of Use

To set the country of use channel map, press **Menu/Enter** knob to select country. Rotate **Menu/Enter** knob to scroll and select country of choice then press and release **Menu/Enter** to select.

Level 1:

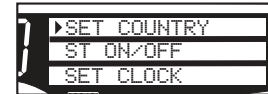

Level 2:

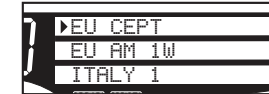

Level 3:



Level 4:

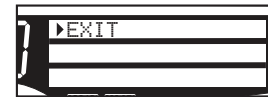
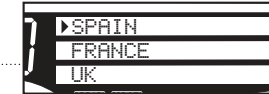

### Setting the Clock

Using the clock, alarm and countdown functions.

To set the clock, press **Menu/Enter** knob and select **Set Clock**.

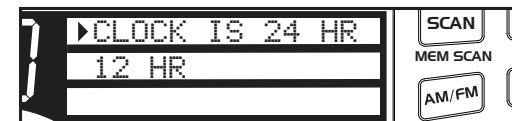
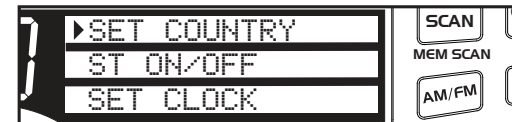

**24:00** will appear in the display and the hours will flash. Rotate **Menu/Enter** knob *clockwise* to select desired hour and press to set.

## Setting the Clock

### Note

Normal display will appear if clock has not yet been set.

### Note

The clock should be connected to constant 12V to run continuously.

# Operation

## Setting the Clock *Continued*

The minutes will then flash. Rotate **Menu/Enter** knob again to select desired minutes and press to set.

For 12:00 hour clock, once the minutes are set, AM or PM will then flash. Rotate **Menu/Enter** knob again to select **AM** or **PM** and press to set or scroll down to **EXIT** and press to return to main menu.



## Setting the Alarm

### Note

Default snooze time length is 10 minutes.

### Note

Default alarm length is 60 seconds and is set in 10 second increments.

## Setting the Alarm

Your 29 LX EU can be utilised as an alarm clock.

To set the alarm, press **Menu/Enter** knob and select **Set Alarm**.

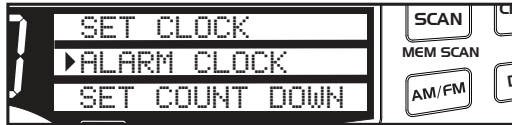

Rotate **Menu/Enter** knob *clockwise* to select **Set Alarm Time**. Follow instructions above for setting the alarm time and AM or PM on 12:00 hour clock.

Once alarm settings are complete, rotate **Menu/Enter** knob *clockwise* to **Set Snooze** and press to select.

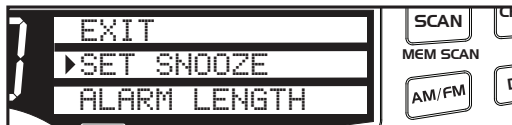

Enter desired snooze time (from 1 to 60 minutes). Select **Enter** to exit, return to Set Snooze or Alarm Length. Select Alarm Length to set alarm duration (from 10 to 300 seconds). Pressing **Menu/Enter** knob returns unit to exit, Set Snooze or Alarm Length.

# Operation

## Setting the Count Down Timer

To set the count down timer, press **Menu/Enter** knob and select **Set Count Down**.

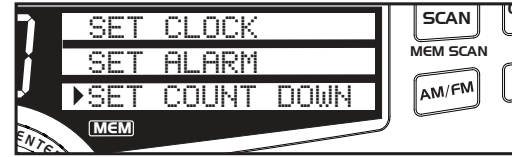

Follow instructions in **Setting the Clock** section (page 17) to set count down hour and minutes. Once desired count down time is selected, press **Menu/Enter** knob again to set and return to the standby menu.

## Key Tones Mode On and Off

Press **Menu/Enter** knob and rotate *clockwise* to **Set Key Tones**. Press **Menu/Enter** to set Key Tones **On/Off**.



Press **Menu/Enter** knob to select **On/Off** and exit to main menu.

## Setting the Count Down Timer

## Key Tones Mode

# Operation

## Radio Check Mode

### Note

Press Dim/Escape button to return to CB standby mode. If 10 seconds pass or if Enter button pressed, unit goes to 2nd test.

### Note

Press Push-To-Talk within 10 seconds or unit will go to the next test.

### Note

Press Dim/Escape button to return to CB standby mode. If 10 seconds pass or if Enter button pressed, go to 3rd test.

## Radio Check Mode

Allows testing of important radio functions.

**Test 1- Battery Level:** Confirms that battery voltage level is between 10.8 V and 15.8 V. If in that range, it is "PASS". Outside of that range, either FAIL LOW" or "FAIL HIGH" will be displayed. Press Menu/Enter knob to advance to next test.

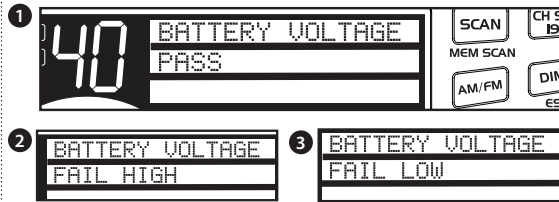

**Test 2- RF Power Output:** Confirms 3.3 to 4 Watt output level. Once Push-to-Talk button is pressed, Pass or Fail will be displayed if level is outside limits.

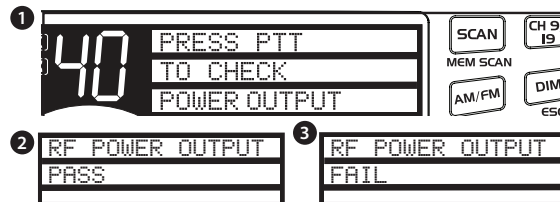

# Operation

## Radio Check Mode Continued

### Note

Press Dim/Escape button to return to CB standby mode. If 10 seconds pass or if Enter button pressed, testing is complete. Unit will return to CB Standby mode.

**Test 3- Antenna Mismatch Warning:** Press Push-to-Talk button to check antenna/radio for proper matching.

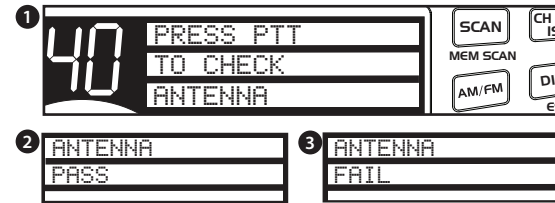

# Operation

## Setting Display Colour Mode

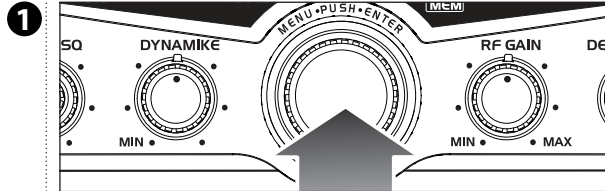

Press **Menu/Enter** knob and scroll down to select **Display Colour**.



Press and release **Menu/Enter** to set the colour.

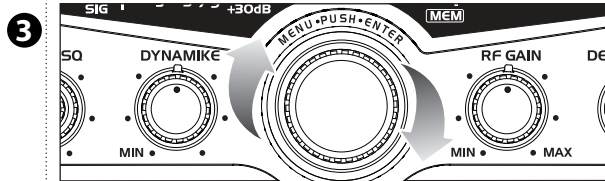

Rotating **Menu/Enter** knob *clockwise* changes the display colour from green to blue to amber to red then back to green.



Press **Menu/Enter** knob or escape button again to exit routine.

### Note

Select **EXIT** to return to main menu. Press **Dim/Escape** button to return to **CB mode**.

# Operation

## Setting Brightness Mode

Press **Menu/Enter** knob to select **Set Brightness**



Rotate **Menu/Enter** knob *clockwise* to **Select Brightness**. Press **Menu/Enter** knob to select **Day-Bright**. Turn **Menu/Enter** *clockwise* to increase brightness and turn *anticlockwise* to decrease brightness.



To set the day bright level, turn the **Menu/Enter** knob *clockwise* to a desired setting and then press **Menu/Enter**. To set the **Night-Dim** level, repeat instructions above then select **Night-Dim**.

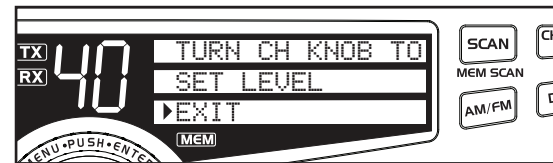

Press **Menu/Enter** knob again to exit routine.

## Setting Brightness Mode

### Note

If an attempt is made to exceed the highest or lowest brightness levels, 1 error beep will be heard.

### Note

Exit will return to menu mode. **ESC** will exit and return to **CB Standby**.

### Note

To select day or night levels, press and release **Dim/Escape** button once levels are set.

# Operation

## Setting Contrast Mode

**Note**  
If an attempt is made to exceed the highest or lowest contrast levels, 1 error beep will be heard.

### Setting Contrast Mode

Press **Menu/Enter** knob and rotate *clockwise* to select **Set Contrast**. Press **Menu/Enter** knob again and rotate *clockwise* to increase contrast, *anticlockwise* to decrease contrast. Press **Menu/Enter** knob to set contrast.



Press **Menu/Enter** knob again to exit routine.

# Operation

## Software Version/Factory Settings

### Software Version/Factory Settings

Displays current software version and returns unit to original factory settings. To view software version, rotate **Menu/Enter** knob *clockwise* to select **Settings** then **Software Version**.

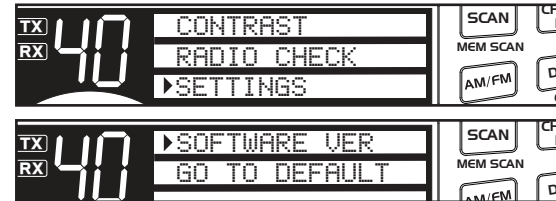

To restore default settings, Press **Menu/Enter** knob again. Rotate **Menu/Enter** knob *clockwise* to select **Settings** then **Go To Default**.

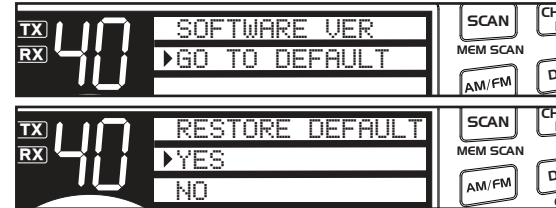

Press **Menu/Enter** knob to restore default settings. Choose **NO** to maintain present setting with no change.

**Note**  
Default display colour is green.

# Operation

## NB-ANL/OFF (Noise Blanker / Automatic Noise Limiter) Button

### Note

The RF noise blanker is very effective in reducing repetitive noises such as ignition interference.

## NB-ANL/OFF (Noise Blanker/Automatic Noise Limiter) Button

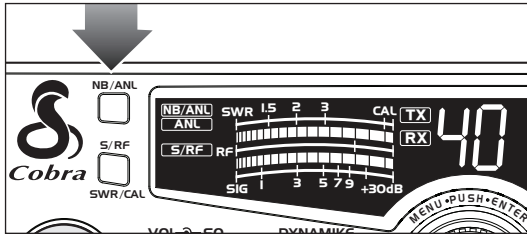

- 1 When switched to ANL the Automatic Noise Limiter is activated. This helps reduce noise created by the vehicle's electronics.

When switched to NB/ANL mode the RF Noise Blanker is also activated, providing increased noise filtration.

When switched to OFF mode all noise filtration will be turned off.

## RF Gain Control

### RF Gain Control

The RF Gain is used to optimise reception in strong or weak signal areas.

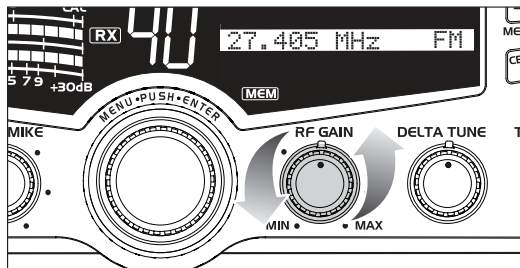

- 1 Rotate the RF Gain knob anticlockwise to reduce gain in strong signal areas. In weak signal areas turn clockwise to increase gain.

# Operation

## Program Memory Channels

Set first channel. Press and hold **Scan/MemScan** button. Memory icon will appear. Select second channel, press and hold **Scan/MemScan** button again until Memory icon appears. Repeat above steps to enter up to 10 channels in memory.

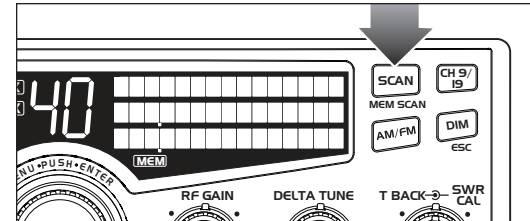
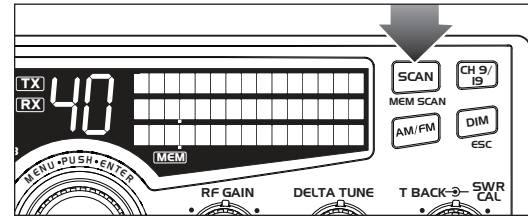

- 1 Pressing the **Scan/Memory Scan** button toggles from **Off** to **Scan All Channels to Memory Channel Only Scan** and back to **Off**.

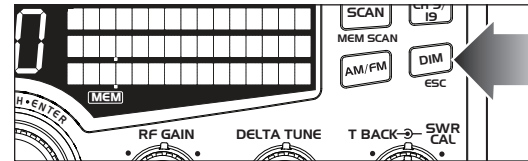

- 2 Press **Dim/Escape** button to end Scan and return to CB mode.

## Program Memory Channels

### Note

The radio should be squelched before scan features are activated.

### Note

Keying the microphone will stop the scan feature.

### Note

If you attempt to program more than 10 channels, 3 error beeps will be heard and "Memory Full" will be displayed for 10 seconds or until any button is pushed.

### Note

To remove a channel from memory, go to the unwanted memory channel then press and hold the scan button until the MEM icon turns off.

# Operation

## Scan CB Channels

### Scan CB Channels

To scan all channels, the unit must be squelched. Press and release **Scan/Mem Scan** button once.

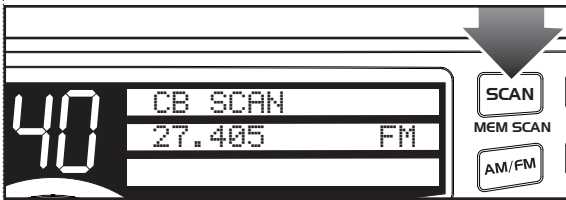

## Scan Memory Channels

### Scan Memory Channels

To scan memory channels, press and release **Scan/Mem Scan** button twice.

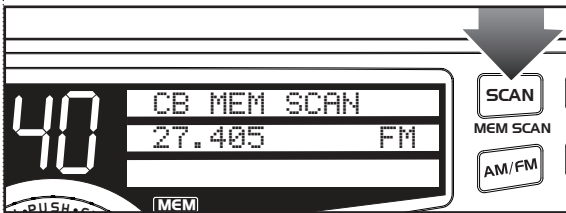

## Dimmer Control

### Dimmer Control

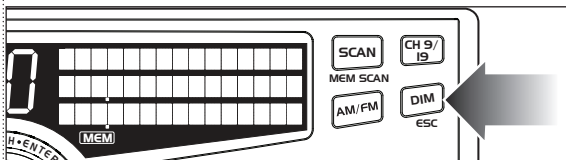

- 1 Press **Dim/Esc** button to toggle between day and night settings. See setting instructions on page 23.

# Operation

## Setting Squelch

Squelch is the "control gate" for incoming signals.

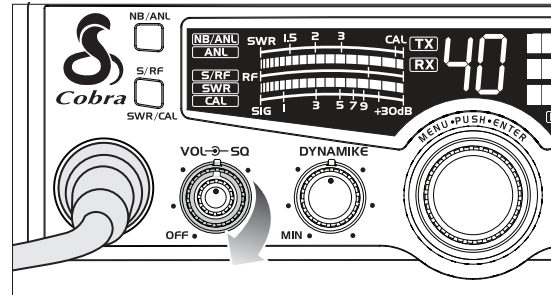

- 1 Full *clockwise* rotation closes the gate, allowing only very strong signals to enter.

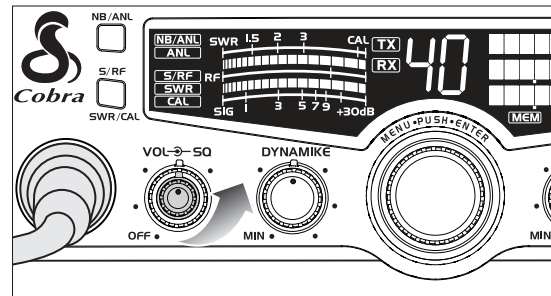

- 2 Full *anticlockwise* rotation opens the "gate" allowing all signals in.

## Setting Squelch

### Gate closed

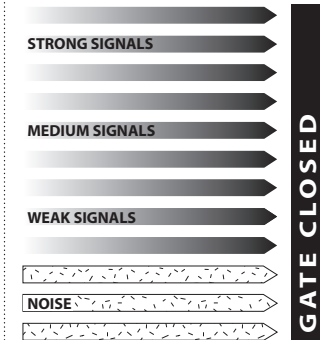

### Gate open

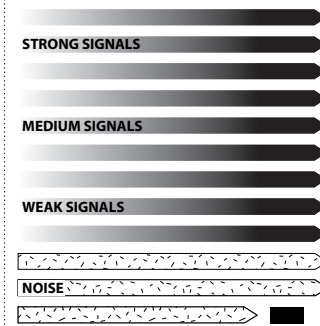

## Setting Squelch

Continued

Gate set to Desired Squelch Setting (DSS)

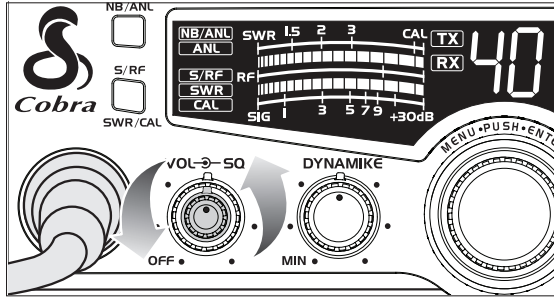
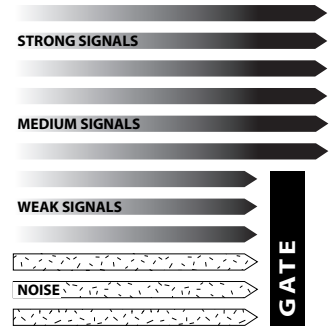

- 3 To achieve the Desired Squelch Setting (DSS), turn the Squelch control *anticlockwise* until you hear noise. Now turn the control *clockwise* just until the noise stops. This is the DSS setting.

## External Speaker

The external speaker jack is used for remote receiver monitoring.

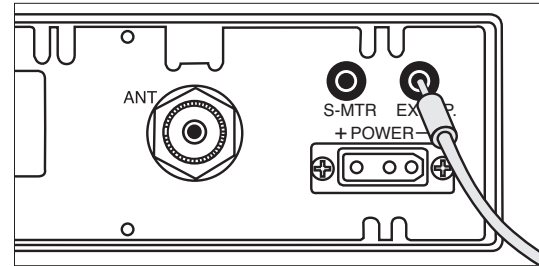

- 1 Connect an external speaker to the external speaker jack on the rear panel.
- 2 Connect external S-Meter to jack for use of external S-Meter (not supplied).

## External Speaker

### Note

The external speaker should have 8-ohm impedance and be rated to handle at least 4.0 watts. When the external speaker is plugged in, the internal speaker is automatically disconnected.

### Note

Cobra external speakers are rated at 10 watts.

### Note

External S-Meter indicates receive/transmit signal strength only.

# Home And Office Set-Up

## Base Station Operation (From 230V AC House Current)

### Base Station Operation (From 230V AC House Current)

To operate your transceiver from home or office you will need a 13.2 volt DC Power Pack rated at a minimum of 2 amps, and a properly installed base station antenna.

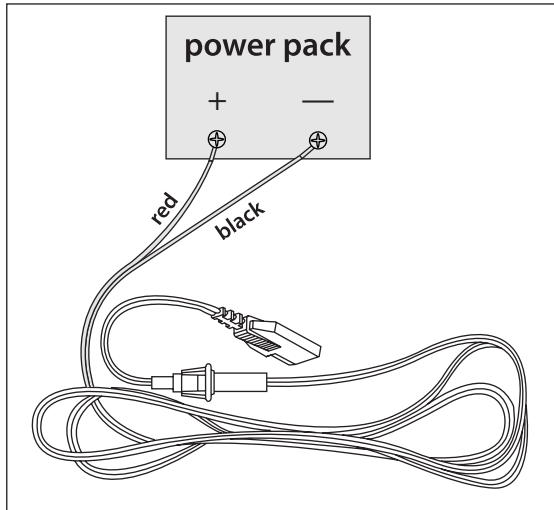

- 1 Simply connect the red (+) and black (-) leads of the transceiver to the corresponding terminals of the power pack.

# Temporary Mobile Set-Up

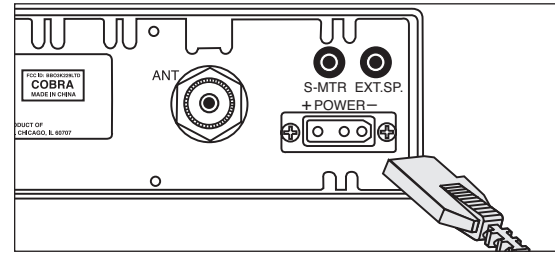

- 2 Plug power cable into back of unit marked "Power". Be sure to observe polarity markings.
- 3 Connect properly installed and matched base station antenna.



**Warning!**  
Do not attempt to operate this transceiver by connecting it directly to 230V AC.

# Frequency Ranges

Band	Channels	Power	Country	(MHz)
EU	40 CH AM	1W	Europe/France	CEPT Frequencies
EU	40 CH FM	4W	Europe/France	CEPT Frequencies 26.965-27.405
CE	40 CH FM only	4W		CEPT Frequencies
UK	40 CH FM	4W	England (UK)	UK Frequencies
UK	40 CH FM	4W	England (UK)	CEPT Frequencies
PL	40 CH AM	4W	Poland	Polish Frequencies
PL	40 CH FM	4W	Poland	Polish Frequencies
E1	40 CH AM	4W	Italy/Spain	CEPT Frequencies
E1	40 CH FM	4W	Italy/Spain	CEPT Frequencies
I2	36 CH AM	4W	Italy	Italian Frequencies
I2	36 CH FM	4W	Italy	Italian Frequencies
DE	40 CH AM	1W	Germany	26.965 (CH1) to 27.405(CH40) CEPT Frequencies
DE	80 CH FM	4W	Germany	1st 40 CH CEPT Frequencies 2nd 40 CH German Frequencies

**NOTE:** If the country of usage is not listed above, please consult with your local communications authority for frequency usage.

# Frequency Ranges

Band ID EU: EU		Band ID CE: CEPT		Band ID UK: United Kingdom		Band ID PL: Poland		Band ID E1: Spain	
AM	1.0W	FM	4.0W	40 CH	FM 4.0W	AM	4.0W	AM	4.0W
FM	4.0W					FM	4.0W	FM	4.0W
Ch. No.	Freq.(MHz)	Ch. No.	Freq.(MHz)	Ch. No.	Freq.(MHz)	Ch. No.	Freq.(MHz)	Ch. No.	Freq.(MHz)
1	26.965	1	26.965	1	27.60125	1	26.960	1	26.965
2	26.975	2	26.975	2	27.61125	2	26.970	2	26.975
3	26.985	3	26.985	3	27.62125	3	26.980	3	26.985
4	27.005	4	27.005	4	27.63125	4	27.000	4	27.005
5	27.015	5	27.015	5	27.64125	5	27.010	5	27.015
6	27.025	6	27.025	6	27.65125	6	27.020	6	27.025
7	27.035	7	27.035	7	27.66125	7	27.030	7	27.035
8	27.055	8	27.055	8	27.67125	8	27.050	8	27.055
9	27.065	9	27.065	9	27.68125	9	27.060	9	27.065
10	27.075	10	27.075	10	27.69125	10	27.070	10	27.075
11	27.085	11	27.085	11	27.70125	11	27.080	11	27.085
12	27.105	12	27.105	12	27.71125	12	27.100	12	27.105
13	27.115	13	27.115	13	27.72125	13	27.110	13	27.115
14	27.125	14	27.125	14	27.73125	14	27.120	14	27.125
15	27.135	15	27.135	15	27.74125	15	27.130	15	27.135
16	27.155	16	27.155	16	27.75125	16	27.150	16	27.155
17	27.165	17	27.165	17	27.76125	17	27.160	17	27.165
18	27.175	18	27.175	18	27.77125	18	27.170	18	27.175
19	27.185	19	27.185	19	27.78125	19	27.180	19	27.185
20	27.205	20	27.205	20	27.79125	20	27.200	20	27.205
21	27.215	21	27.215	21	27.80125	21	27.210	21	27.215
22	27.225	22	27.225	22	27.81125	22	27.220	22	27.225
23	27.255	23	27.255	23	27.82125	23	27.250	23	27.255
24	27.235	24	27.235	24	27.83125	24	27.230	24	27.235
25	27.245	25	27.245	25	27.84125	25	27.240	25	27.245
26	27.265	26	27.265	26	27.85125	26	27.260	26	27.265
27	27.275	27	27.275	27	27.86125	27	27.270	27	27.275
28	27.285	28	27.285	28	27.87125	28	27.280	28	27.285
29	27.295	29	27.295	29	27.88125	29	27.290	29	27.295
30	27.305	30	27.305	30	27.89125	30	27.300	30	27.305
31	27.315	31	27.315	31	27.90125	31	27.310	31	27.315
32	27.325	32	27.325	32	27.91125	32	27.320	32	27.325
33	27.335	33	27.335	33	27.92125	33	27.330	33	27.335
34	27.345	34	27.345	34	27.93125	34	27.340	34	27.345
35	27.355	35	27.355	35	27.94125	35	27.350	35	27.355
36	27.365	36	27.365	36	27.95125	36	27.360	36	27.365
37	27.375	37	27.375	37	27.96125	37	27.370	37	27.375
38	27.385	38	27.385	38	27.97125	38	27.380	38	27.385
39	27.395	39	27.395	39	27.98125	39	27.390	39	27.395
40	27.405	40	27.405	40	27.99125	40	27.400	40	27.405

# Frequency Ranges continued

# 29 LX EU Specifications

Band ID EU: France		Band ID I1: Italy 1		Band ID I2: Italy 2		Band ID DE: Germany			
AM	1.0W	AM	4.0W	AM	4.0W	40 CH	AM 1.0W		
FM	4.0W	FM	4.0W	FM	4.0W	80 CH	FM 4.0W		
Ch. No.	Freq.(MHz)	Ch. No.	Freq.(MHz)	Ch. No.	Freq.(MHz)	Ch. No.	Freq.(MHz)	Ch. No.	Freq.(MHz)
1	26.965	1	26.965	1	26.965	1	26.965	41	26.565
2	26.975	2	26.975	2	26.975	2	26.975	42	26.575
3	26.985	3	26.985	3	26.985	3	26.985	43	26.585
4	27.005	4	27.005	4	27.005	4	27.005	44	26.595
5	27.015	5	27.015	5	27.015	5	27.015	45	26.605
6	27.025	6	27.025	6	27.025	6	27.025	46	26.615
7	27.035	7	27.035	7	27.035	7	27.035	47	26.625
8	27.055	8	27.055	8	27.055	8	27.055	48	26.635
9	27.065	9	27.065	9	27.065	9	27.065	49	26.645
10	27.075	10	27.075	10	27.075	10	27.075	50	26.655
11	27.085	11	27.085	11	27.085	11	27.085	51	26.665
12	27.105	12	27.105	12	27.105	12	27.105	52	26.675
13	27.115	13	27.115	13	27.115	13	27.115	53	26.685
14	27.125	14	27.125	14	27.125	14	27.125	54	26.695
15	27.135	15	27.135	15	27.135	15	27.135	55	26.705
16	27.155	16	27.155	16	27.155	16	27.155	56	26.715
17	27.165	17	27.165	17	27.165	17	27.165	57	26.725
18	27.175	18	27.175	18	27.175	18	27.175	58	26.735
19	27.185	19	27.185	19	27.185	19	27.185	59	26.745
20	27.205	20	27.205	20	27.205	20	27.205	60	26.755
21	27.215	21	27.215	21	27.215	21	27.215	61	26.765
22	27.225	22	27.225	22	27.225	22	27.225	62	26.775
23	27.255	23	27.255	23	27.255	23	27.255	63	26.785
24	27.235	24	27.235	24	27.245	24	27.235	64	26.795
25	27.245	25	27.245	25	27.265	25	27.245	65	26.805
26	27.265	26	27.265	26	26.875	26	27.265	66	26.815
27	27.275	27	27.275	27	26.885	27	27.275	67	26.825
28	27.285	28	27.285	28	26.895	28	27.285	68	26.835
29	27.295	29	27.295	29	26.905	29	27.295	69	26.845
30	27.305	30	27.305	30	26.915	30	27.305	70	26.855
31	27.315	31	27.315	31	26.925	31	27.315	71	26.865
32	27.325	32	27.325	32	26.935	32	27.325	72	26.875
33	27.335	33	27.335	33	26.945	33	27.335	73	26.885
34	27.345	34	27.345	34	26.955	34	27.345	74	26.895
35	27.355	35	27.355	35	26.855	35	27.355	75	26.905
36	27.365	36	27.365	36	26.865	36	27.365	76	26.915
37	27.375	37	27.375			37	27.375	77	26.925
38	27.385	38	27.385			38	27.385	78	26.935
39	27.395	39	27.395			39	27.395	79	26.945
40	27.405	40	27.405			40	27.405	80	26.955

## GENERAL

Channels.....	FM/AM
Frequency Range.....	26.565 to 27.99125 MHz
Frequency Tolerance.....	0.005 %
Frequency Control.....	PLL (Phase Lock Loop) Synthesizer
Operating Temperature Range.....	-30° C TO + 65° C
Microphone.....	Plug-in dynamic
Input Voltage.....	13.2 VDC nom. (negative ground)
Current Drain.....	Transmit: AM/FM full mod., 1.4A (maximum) Receive: Squelched, 0.9 A; Full audio output, 1.2A (nominal)
Maximum Duty Cycle.....	5 minute transmit 5 minute stand-by
Size.....	8.625"W x 7.28125"W x 2.8125"H
Weight.....	4 lbs.
Antenna Connector.....	UHF; SO-239
Meter.....	LCDs; indicates relative power output and received signal strength

## TRANSMITTER

Power Output.....	4 watts FM, 4/1 watt AM
Modulation.....	AM (Amplitude Modulation) FM (Frequency Modulation)
Frequency Response.....	300 to 3000 Hz
Output Impedance.....	50 ohms, unbalanced

## RECEIVER

Sensitivity.....	Less than 1 μV for 10 dB (S+N) /N
Selectivity.....	6 dB @ 7 KHz, 60 dB @ 10KHz
Image Rejection.....	.80 dB, typical
Adjacent-Channel Rejection.....	.60 dB, typical
IF Frequencies.....	Double Conversion: 1st: 10.695 MHz 2nd: 455 KHz
Automatic Gain Control (AGC).....	Less than 10 dB change in audio output for inputs from 10 to 50,000 microvolts
RF Gain range.....	40 db
Noise Blanker.....	RF type
Squelch.....	Adjustable; threshold less than 1μV
Audio Output Power.....	.4 watts
Frequency Response.....	300 to 3000 Hz
Distortion.....	Less than 7% @3 watts @ 1000 Hz
Built-in Speaker.....	8 ohms, 5w
External Speaker (Not supplied).....	8 ohms; disables internal speaker when connected

(SPECIFICATIONS SUBJECT TO CHANGE WITHOUT NOTICE)

## Trademark Acknowledgement

Cobra®, Nothing Comes Close to a Cobra® and the snake design are registered trademarks of Cobra Electronics Corporation, USA. Cobra Electronics Corporation™ is a trademark of Cobra Electronics Corporation, USA.

# Optional Accessories

You can find quality Cobra products and accessories at your local Cobra dealer.

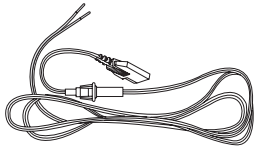

**Replacement DC Power Cord**  
For in vehicle use

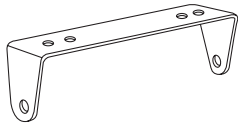

**Replacement Mounting Bracket**

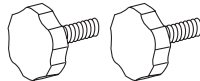

**Replacement Thumb Screws**

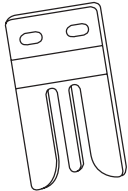

**Replacement Microphone Bracket**



**21" Base Loaded Magnet Mount Antenna**

HG A1000



**38" Base Loaded Magnet Mount Antenna**

HG A1500



**Dynamic External Speaker**

HG S100



**Noise Cancelling External Speaker**

HG S300



**Noise Cancelling With Talk Back External Speaker**

HG S500

# Declaration of Conformity

## Declaration of Conformity

We, Cobra Electronics Europe Limited of  
Dungar House  
Northumberland Avenue  
Dun Laoghaire  
County Dublin, Ireland

Declare under our sole responsibility that the product:

**29 LX EU  
CB radio**

to which this declaration relates, is in conformity with the following standards and/ or other normative documents when properly installed and maintained and used for their intended purpose:

**EN60950-1:2006 + A11:2009 + A1:2010 + A12:2011**

**EN62311 (2008)**

**EN 301 489-1 V1.8.1 (2008-04)**

**EN 301 489-13 V1.2.1 (2002-08)**

**EN 300 433-2 V1.3.1 (2011-07)**

We hereby declare that the above named product is in conformity to all the essential requirements of the Directive 1999/5/EC.

The conformity assessment procedure referred to in Article 10 and detailed in Annex III or IV of Directive 1999/5/EC has been followed with the involvement of the following Notified Body:

**BABT, Forsyth House, Churchfield Road, Walton-on-Thames, Surrey, KT12 2TD, UK**

**Identification mark 0168 (Notified Body Number)**

The equipment will also carry the Class 2 equipment identifier: 

**CE0168**

**The technical documentation relevant to the above equipment will be held at:**

Cobra Electronics Europe Limited of  
Dungar House  
Northumberland Avenue  
Dun Laoghaire  
County Dublin, Ireland

JEAN-LOUIS POOT, Managing Director

December 2011